

# D44H Series (NPN), D45H Series (PNP)

## Complementary Silicon Power Transistors

These series of plastic, silicon NPN and PNP power transistors can be used as general purpose power amplification and switching such as output or driver stages in applications such as switching regulators, converters and power amplifiers.

### Features

- Low Collector–Emitter Saturation Voltage
- Fast Switching Speeds
- Complementary Pairs Simplifies Designs
- These Devices are Pb–Free and are RoHS Compliant\*

### MAXIMUM RATINGS

Rating	Symbol	Value	Unit
Collector–Emitter Voltage D44H8, D45H8 D44H11, D45H11	$V_{CEO}$	60 80	Vdc
Emitter Base Voltage	$V_{EB}$	5.0	Vdc
Collector Current – Continuous	$I_C$	10	Adc
Collector Current – Peak (Note 1)	$I_{CM}$	20	Adc
Total Power Dissipation @ $T_C = 25^\circ\text{C}$ @ $T_A = 25^\circ\text{C}$	$P_D$	70 2.0	W
Operating and Storage Junction Temperature Range	$T_J, T_{stg}$	–55 to +150	$^\circ\text{C}$

Stresses exceeding those listed in the Maximum Ratings table may damage the device. If any of these limits are exceeded, device functionality should not be assumed, damage may occur and reliability may be affected.

1. Pulse Width  $\leq 6.0$  ms, Duty Cycle  $\leq 50\%$ .

### THERMAL CHARACTERISTICS

Characteristic	Symbol	Max	Unit
Thermal Resistance, Junction–to–Case	$R_{\theta JC}$	1.8	$^\circ\text{C}/\text{W}$
Thermal Resistance, Junction–to–Ambient	$R_{\theta JA}$	62.5	$^\circ\text{C}/\text{W}$
Maximum Lead Temperature for Soldering Purposes: 1/8" from Case for 5 Seconds	$T_L$	275	$^\circ\text{C}$

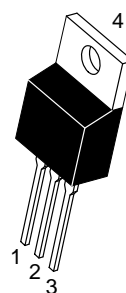
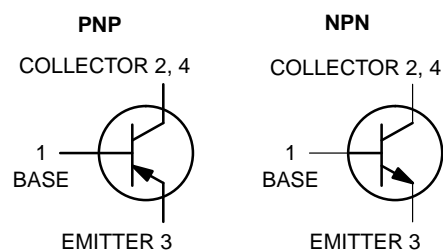
\*For additional information on our Pb–Free strategy and soldering details, please download the ON Semiconductor Soldering and Mounting Techniques Reference Manual, SOLDERRM/D.



ON Semiconductor®

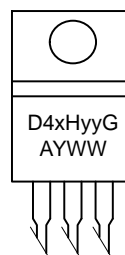
[www.onsemi.com](http://www.onsemi.com)

## 10 AMP COMPLEMENTARY SILICON POWER TRANSISTORS 60, 80 VOLTS



TO-220  
CASE 221A  
STYLE 1

### MARKING DIAGRAM



D4xHy = Device Code  
x = 4 or 5  
yy = 8 or 11

A = Assembly Location  
Y = Year  
WW = Work Week  
G = Pb–Free Package

### ORDERING INFORMATION

Device	Package	Shipping
D44H8G	TO-220 (Pb–Free)	50 Units/Rail
D44H11G	TO-220 (Pb–Free)	50 Units/Rail
D45H8G	TO-220 (Pb–Free)	50 Units/Rail
D45H11G	TO-220 (Pb–Free)	50 Units/Rail

## D44H Series (NPN), D45H Series (PNP)

### ELECTRICAL CHARACTERISTICS (T<sub>C</sub> = 25°C unless otherwise noted)

Characteristic	Symbol	Min	Typ	Max	Unit
----------------	--------	-----	-----	-----	------

#### OFF CHARACTERISTICS

Collector–Emitter Sustaining Voltage (I <sub>C</sub> = 30 mA, I <sub>B</sub> = 0 A)	D44H8, D45H8 D44H11, D45H11	V <sub>CE(sus)</sub>	60 80	– –	– –	Vdc
Collector Cutoff Current (V <sub>CE</sub> = Rated V <sub>CEO</sub> , V <sub>BE</sub> = 0)		I <sub>CES</sub>	–	–	10	μA
Emitter Cutoff Current (V <sub>EB</sub> = 5.0 Vdc)		I <sub>EBO</sub>	–	–	10	μA

#### ON CHARACTERISTICS

DC Current Gain (V <sub>CE</sub> = 1.0 Vdc, I <sub>C</sub> = 2.0 A) (V <sub>CE</sub> = 1.0 Vdc, I <sub>C</sub> = 4.0 A)	h <sub>FE</sub>	60 40	– –	– –	–
Collector–Emitter Saturation Voltage (I <sub>C</sub> = 8.0 A, I <sub>B</sub> = 0.4 A)	V <sub>CE(sat)</sub>	–	–	1.0	Vdc
Base–Emitter Saturation Voltage (I <sub>C</sub> = 8.0 A, I <sub>B</sub> = 0.8 A)	V <sub>BE(sat)</sub>	–	–	1.5	Vdc

#### DYNAMIC CHARACTERISTICS

Collector Capacitance (V <sub>CB</sub> = 10 Vdc, f <sub>test</sub> = 1.0 MHz)	D44H Series D45H Series	C <sub>cb</sub>	– –	90 160	– –	pF
Gain Bandwidth Product (I <sub>C</sub> = 0.5 A, V <sub>CE</sub> = 10 Vdc, f = 20 MHz)	D44H Series D45H Series	f <sub>T</sub>	– –	50 40	– –	MHz

#### SWITCHING TIMES

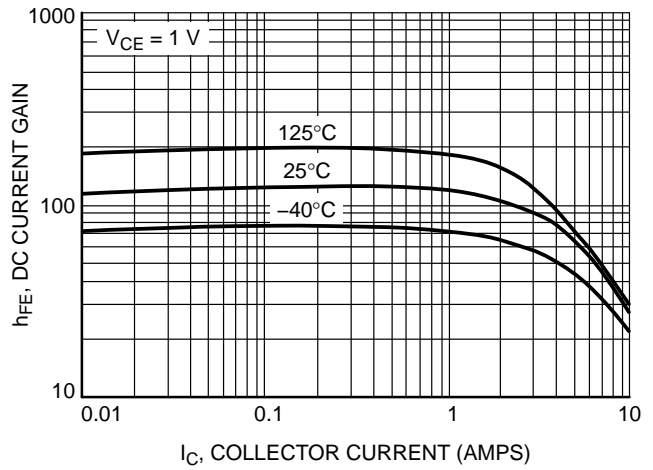
Delay and Rise Times (I <sub>C</sub> = 5.0 A, I <sub>B1</sub> = 0.5 A)	D44H Series D45H Series	t <sub>d</sub> + t <sub>r</sub>	– –	300 135	– –	ns
Storage Time (I <sub>C</sub> = 5.0 A, I <sub>B1</sub> = I <sub>B2</sub> = 0.5 A)	D44H Series D45H Series	t <sub>s</sub>	– –	500 500	– –	ns
Fall Time (I <sub>C</sub> = 5.0 A, I <sub>B1</sub> = 102 = 0.5 A)	D44H Series D45H Series	t <sub>f</sub>	– –	140 100	– –	ns

Product parametric performance is indicated in the Electrical Characteristics for the listed test conditions, unless otherwise noted. Product performance may not be indicated by the Electrical Characteristics if operated under different conditions.

## D44H Series (NPN), D45H Series (PNP)



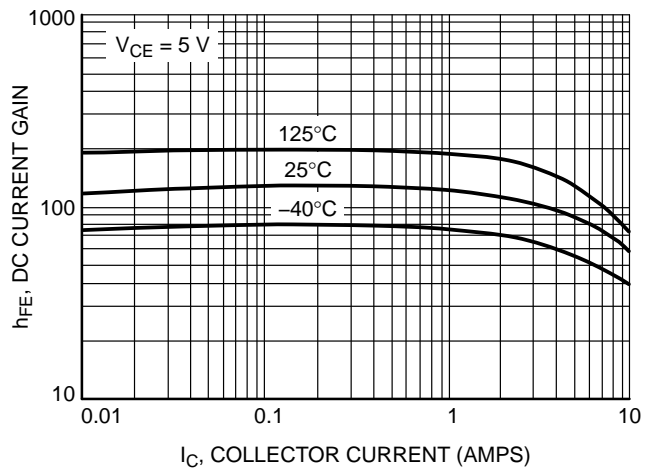
**Figure 1. D44H11 DC Current Gain**



**Figure 2. D45H11 DC Current Gain**



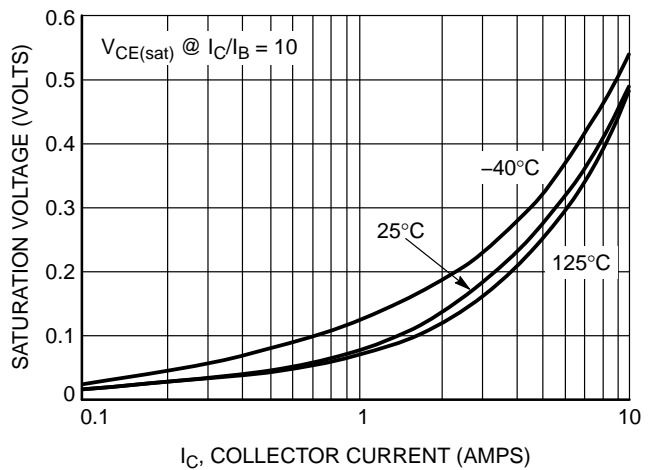
**Figure 3. D44H11 DC Current Gain**



**Figure 4. D45H11 DC Current Gain**

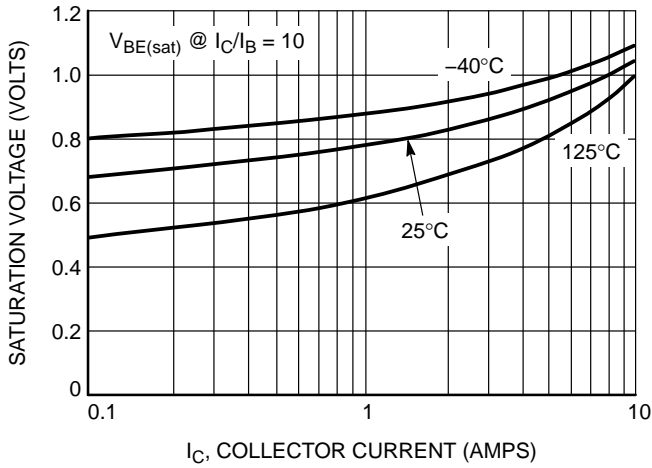


**Figure 5. D44H11 ON-Voltage**

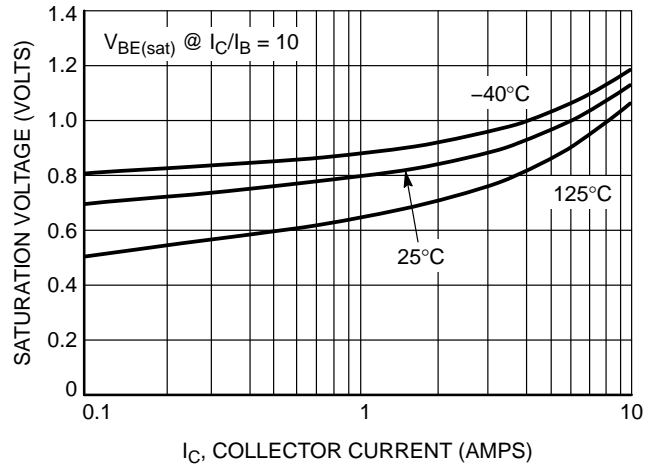


**Figure 6. D45H11 ON-Voltage**

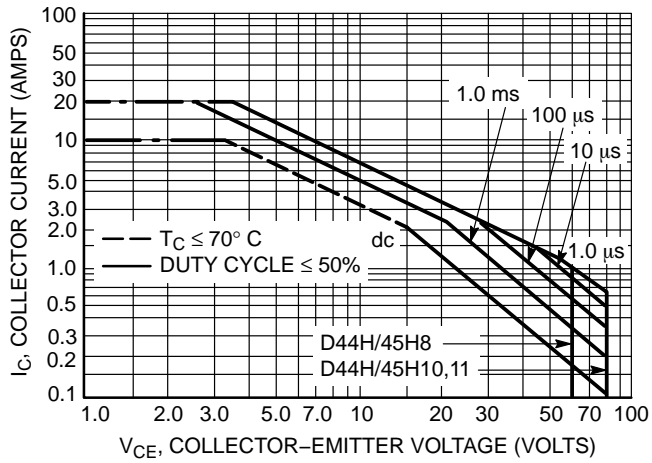
## D44H Series (NPN), D45H Series (PNP)



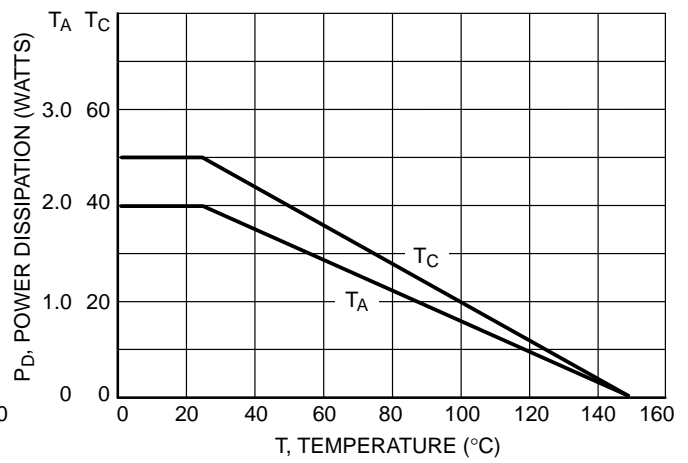
**Figure 7. D44H11 ON-Voltage**



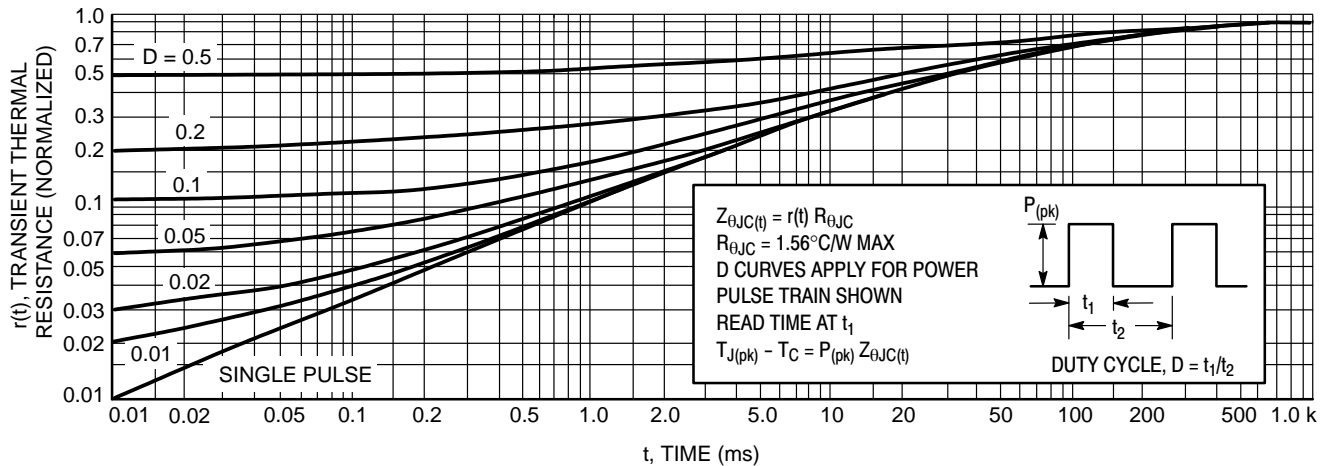
**Figure 8. D45H11 ON-Voltage**



**Figure 9. Maximum Rated Forward Bias Safe Operating Area**



**Figure 10. Power Derating**



**Figure 11. Thermal Response**

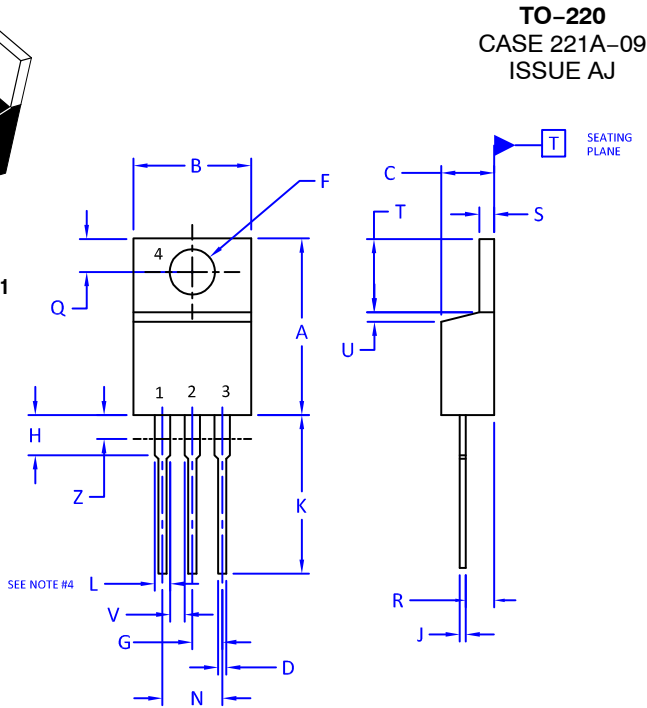
# MECHANICAL CASE OUTLINE

## PACKAGE DIMENSIONS

ON Semiconductor®



SCALE 1:1



**TO-220**  
CASE 221A-09  
ISSUE AJ

DATE 05 NOV 2019

**NOTES:**

1. DIMENSIONING AND TOLERANCING PER ANSI Y14.5M, 2009.
2. CONTROLLING DIMENSION: INCHES
3. DIMENSION Z DEFINES A ZONE WHERE ALL BODY AND LEAD IRREGULARITIES ARE ALLOWED.
4. MAX WIDTH FOR F102 DEVICE = 1.35MM

DIM	INCHES		MILLIMETERS	
	MIN.	MAX.	MIN.	MAX.
A	0.570	0.620	14.48	15.75
B	0.380	0.415	9.66	10.53
C	0.160	0.190	4.07	4.83
D	0.025	0.038	0.64	0.96
F	0.142	0.161	3.60	4.09
G	0.095	0.105	2.42	2.66
H	0.110	0.161	2.80	4.10
J	0.014	0.024	0.36	0.61
K	0.500	0.562	12.70	14.27
L	0.045	0.060	1.15	1.52
N	0.190	0.210	4.83	5.33
Q	0.100	0.120	2.54	3.04
R	0.080	0.110	2.04	2.79
S	0.045	0.055	1.15	1.41
T	0.235	0.255	5.97	6.47
U	0.000	0.050	0.00	1.27
V	0.045	---	1.15	---
Z	---	0.080	---	2.04

**STYLE 1:**

- PIN 1. BASE
- 2. COLLECTOR
- 3. EMITTER
- 4. COLLECTOR

**STYLE 2:**

- PIN 1. BASE
- 2. EMITTER
- 3. COLLECTOR
- 4. EMITTER

**STYLE 3:**

- PIN 1. CATHODE
- 2. ANODE
- 3. GATE
- 4. ANODE

**STYLE 4:**

- PIN 1. MAIN TERMINAL 1
- 2. MAIN TERMINAL 2
- 3. GATE
- 4. MAIN TERMINAL 2

**STYLE 5:**

- PIN 1. GATE
- 2. DRAIN
- 3. SOURCE
- 4. DRAIN

**STYLE 6:**

- PIN 1. ANODE
- 2. CATHODE
- 3. ANODE
- 4. CATHODE

**STYLE 7:**

- PIN 1. CATHODE
- 2. ANODE
- 3. CATHODE
- 4. ANODE

**STYLE 8:**

- PIN 1. CATHODE
- 2. ANODE
- 3. EXTERNAL TRIP/DELAY
- 4. ANODE

**STYLE 9:**

- PIN 1. GATE
- 2. COLLECTOR
- 3. EMITTER
- 4. COLLECTOR

**STYLE 10:**

- PIN 1. GATE
- 2. SOURCE
- 3. DRAIN
- 4. SOURCE

**STYLE 11:**

- PIN 1. DRAIN
- 2. SOURCE
- 3. GATE
- 4. SOURCE

**STYLE 12:**

- PIN 1. MAIN TERMINAL 1
- 2. MAIN TERMINAL 2
- 3. GATE
- 4. NOT CONNECTED

<b>DOCUMENT NUMBER:</b>	<b>98ASB42148B</b>	Electronic versions are uncontrolled except when accessed directly from the Document Repository. Printed versions are uncontrolled except when stamped "CONTROLLED COPY" in red.
<b>DESCRIPTION:</b>	<b>TO-220</b>	<b>PAGE 1 OF 1</b>

ON Semiconductor and are trademarks of Semiconductor Components Industries, LLC dba ON Semiconductor or its subsidiaries in the United States and/or other countries. ON Semiconductor reserves the right to make changes without further notice to any products herein. ON Semiconductor makes no warranty, representation or guarantee regarding the suitability of its products for any particular purpose, nor does ON Semiconductor assume any liability arising out of the application or use of any product or circuit, and specifically disclaims any and all liability, including without limitation special, consequential or incidental damages. ON Semiconductor does not convey any license under its patent rights nor the rights of others.

ON Semiconductor and  are trademarks of Semiconductor Components Industries, LLC dba ON Semiconductor or its subsidiaries in the United States and/or other countries. ON Semiconductor owns the rights to a number of patents, trademarks, copyrights, trade secrets, and other intellectual property. A listing of ON Semiconductor's product/patent coverage may be accessed at [www.onsemi.com/site/pdf/Patent-Marking.pdf](http://www.onsemi.com/site/pdf/Patent-Marking.pdf). ON Semiconductor reserves the right to make changes without further notice to any products herein. ON Semiconductor makes no warranty, representation or guarantee regarding the suitability of its products for any particular purpose, nor does ON Semiconductor assume any liability arising out of the application or use of any product or circuit, and specifically disclaims any and all liability, including without limitation special, consequential or incidental damages. Buyer is responsible for its products and applications using ON Semiconductor products, including compliance with all laws, regulations and safety requirements or standards, regardless of any support or applications information provided by ON Semiconductor. "Typical" parameters which may be provided in ON Semiconductor data sheets and/or specifications can and do vary in different applications and actual performance may vary over time. All operating parameters, including "Typicals" must be validated for each customer application by customer's technical experts. ON Semiconductor does not convey any license under its patent rights nor the rights of others. ON Semiconductor products are not designed, intended, or authorized for use as a critical component in life support systems or any FDA Class 3 medical devices or medical devices with a same or similar classification in a foreign jurisdiction or any devices intended for implantation in the human body. Should Buyer purchase or use ON Semiconductor products for any such unintended or unauthorized application, Buyer shall indemnify and hold ON Semiconductor and its officers, employees, subsidiaries, affiliates, and distributors harmless against all claims, costs, damages, and expenses, and reasonable attorney fees arising out of, directly or indirectly, any claim of personal injury or death associated with such unintended or unauthorized use, even if such claim alleges that ON Semiconductor was negligent regarding the design or manufacture of the part. ON Semiconductor is an Equal Opportunity/Affirmative Action Employer. This literature is subject to all applicable copyright laws and is not for resale in any manner.

## PUBLICATION ORDERING INFORMATION

### LITERATURE FULFILLMENT:

Email Requests to: [orderlit@onsemi.com](mailto:orderlit@onsemi.com)

ON Semiconductor Website: [www.onsemi.com](http://www.onsemi.com)

### TECHNICAL SUPPORT

North American Technical Support:  
Voice Mail: 1 800-282-9855 Toll Free USA/Canada  
Phone: 011 421 33 790 2910

Europe, Middle East and Africa Technical Support:

Phone: 00421 33 790 2910

For additional information, please contact your local Sales Representative